

PUNTO SP1 CLK05

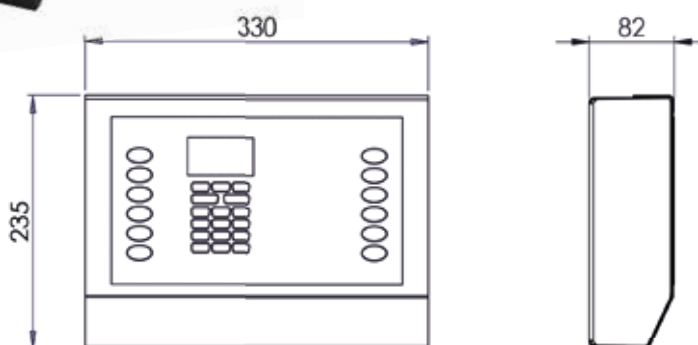

Master clock with flexible programming. Designed to meet ecclesiastic requirements and more: Punto SP1 works both automatically and manually; no technical knowhow required.

The clock can be connected to a bell tower-control panel with a 2-wire or standard RS485 connection.

The classical version comes in white scratch-resistance ABS. Punto SP1.DODICI and .VENTI come in metal casing.

Punto SP1 triples its potential without sacrificing its habitual reliability.

The Punto SP1 master clock comes in 3 versions to cover all operational situations.

Three versions offering 3 performance levels and multiple personalised configurations – and all in a single product.

Flexible, simple and precise are the buzzwords behind the new Ecat project. We have the clock for you whatever your needs and knowhow (from installer to end user). Try us!

From Punto SP1 to Sp1.DODICI and .VENTI

The classical SP1 developed and revamped by Ecat engineers controls up to 44 channels (4 internal + 40 external outputs) with 2 independent controls for slave clocks.

Punto SP1.DODICI, again for up to 44 channels, contains 12 outputs plus a slot for a MIDI keyboard or for use as required.

Punto SP1.VENTI further boosts the internal output capacity to 20, with 2 free slots for a totally personalised master clock.

Punto SP1.DODICI and .VENTI are both compatible with standard MIDI peripherals.

You can now also calculate sunrise and sunset times automatically, simply by inputting the latitude and longitude of your location.

Horloge électronique de contrôle-avertisseur à programmation flexible. Conçue pour répondre aux exigences ecclésiastiques, mais pas seulement: Punto SP1 opère tant en automatique que manuellement et son utilisation ne requiert pas de compétences techniques particulières.

L'horloge électronique de contrôle peut être reliée au tableau de commandes du clocher par un branchement RS485 deux fils ou traditionnel.

La version classique est disponible en ABS inrayable blanc. Tandis que les versions Punto SP1.DODICI et 20 ont un boîtier métallique.

Punto SP1 triple ses potentialités en maintenant sa fiabilité de toujours

L'horloge électronique de contrôle Punto SP1 s'est mise en 3 pour gérer toute situation de travail. 3 versions pour 3 niveaux de performance, de multiples configurations personnalisées, le tout en un seul produit.

Souplesse, simplicité et précision, sont les principes sur lesquels se fonde le nouveau projet Ecat. Quelles que soient vos exigences et compétences (de l'installateur à l'utilisateur final), nous avons l'horloge électronique de contrôle dont vous avez besoin. Mettez-nous à l'épreuve!

De Punto SP1 à SP1.DODICI et .VENTI

La version classique SP1, perfectionnée et revue par les ingénieurs Ecat, offre la possibilité de gérer jusqu'à 44 chaînes (4 sorties internes + 40 externes) avec 2 commandes indépendantes par panneaux secondaire.

Punto SP1.DODICI, toujours pour un maximum de 44 chaînes, renferme 12 sorties plus un slot pour connecter un clavier MIDI ou à utiliser en fonction de vos besoins.

PUNTO SP1 CLK05

Punto SP1.VENTI accroît ultérieurement la capacité de sorties internes jusqu'à 20 avec 2 slots libres pour une personnalisation absolue de votre horloge de contrôle.

Punto SP1.DODICI et .VENTI sont toutes les deux compatibles avec des périphériques standard MIDI.

En outre, à partir d'aujourd'hui il vous sera possible de calculer automatiquement l'horaire du lever et du coucher du soleil, en saisissant tout simplement la latitude et la longitude correspondant à votre position.

TECHNICAL CHARACTERISTICS

All versions feature:

- simple and intuitive interface;
- shortcut program keys (except SP1 Basic, see technical specifications);
- shortcut keys for immediate programming (except for SP1 Basic, see technical specifications);
- backlit, high-contrast keyboard, suitable for visually-impaired users;
- memory card for program backup;
- USB port;
- multi-language menu;
- controls up to 32 bells, 32 electro-magnetic hammers, 16 bells in movement;
- GPS synchronisation, NTP server, DCF77;
- GSM connectivity and Android or IOS management smartphone app for remote clock control;
- MIDI file compatible;
- manual execution and melody recording;
- maxi personalisation of programmable events;
- manual execution and melody recording;
- Easter and Easter festivity calculation;
- multilevel password (up to 6 levels) to control device access.

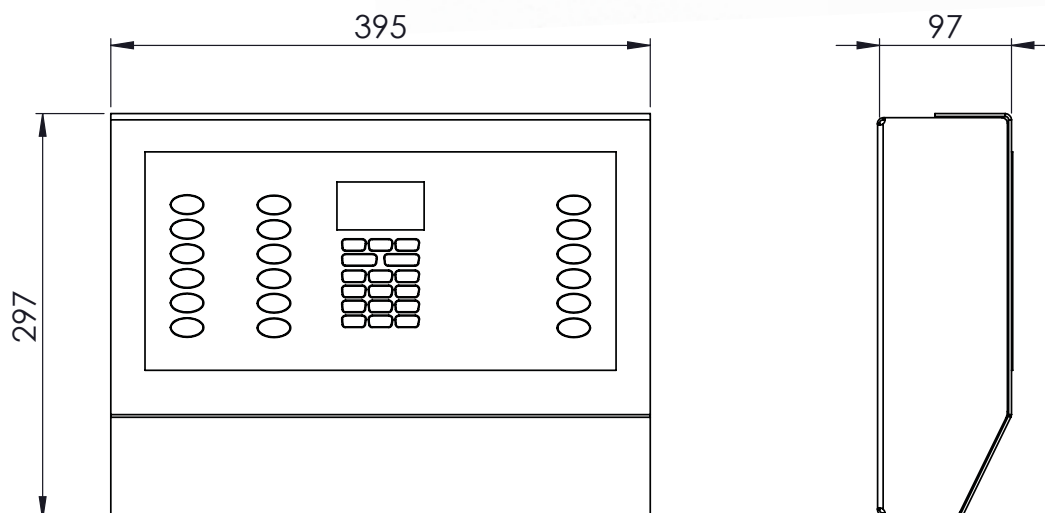

PUNTO SP1 CLK05

CODE	DESCRIPTION	CASING	CHANNELS	LINE 12/24	FUNCTION KEYS	DCF77/ GPS/ NTP	MEMORY CARD USB PORT	STANDARD MIDI DEVICE COMPATIBLE	EXPANSION SLOT
CLK0504001	PUNTO SP1 CLOCK FULL VERSION	PLASTIC	4 - 44	•	6	•	•		
CLK0504002	PUNTO SP1 CLOCK FULL VERSION 110V	PLASTIC	4 - 44	•	6	•	•		
CLK0504020	PUNTO SP1 CLOCK STANDARD VERSION	PLASTIC	4 - 44		6	•	•		
CLK0504021	PUNTO SP1 CLOCK STANDARD VERSION 110V	PLASTIC	4 - 44		6	•	•		
CLK0504022	PUNTO SP1 CLOCK BASIC VERSION	PLASTIC	4 - 44			•	•		
CLK0504023	PUNTO SP1 CLOCK BASIC VERSION 110V	PLASTIC	4 - 44			•	•		
CLK0504040	PUNTO SP1.DODICI CLOCK 110/220V	METAL	12 - 44		6	•	•	•	1
CLK0504050	PUNTO SP1.VENTI CLOCK 110/220V	METAL	20 - 44		12	•	•	•	2
CLK0504060	PUNTO SP1 CLOCK RACK 110/220V	METAL	12 - 44		12	•	•	•	1
CLK0504070	PUNTO SP1 CLOCK "LARGE CASE" 110/220V	METAL	12 - 44		12	•	•	•	1



PUNTO SP1
CLK05

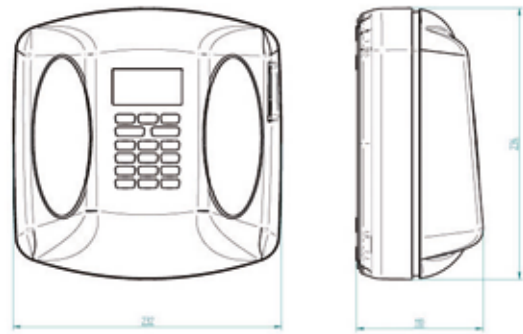
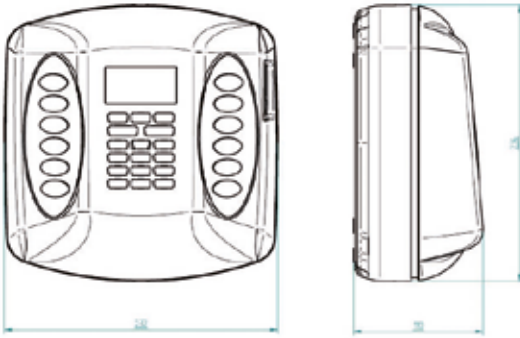

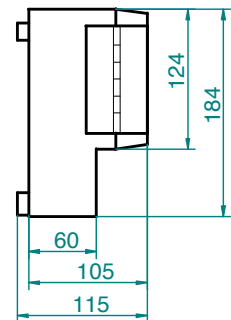
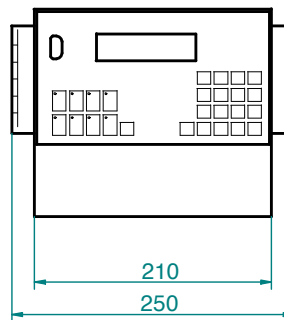
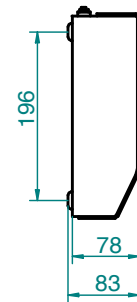
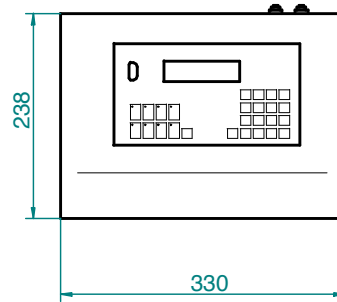

Receiver and transmitter master clock with annual programming on 4 channels with 2 independent commands for secondary clocks 12-24 VDC and 220 VAC. Particularly well suited for the command of bell automation system, tower clocks, hour striking and for the service planning. It is equipped with a large memory capacity which allows to storage and change melodies directly from the keyboard of the clock. The following are some of the features that make this device complete and versatile: the interface for the synchronization via DCF radio, the possibility to interact with the computer and the planning by phone.

Horloge mère, modèle indépendant ou récepteur à 4 circuits de programmation et double commande indépendante d'horloges secondaires 12-24 VDC et 220 VAC.

Cette horloge est particulièrement indiquée pour les commandes manuelles et automatiques des cloches d'églises et des horloges monumentales, et pour la mise en marche des sonneries usuelles (heures et services). Elle est dotée d'une grande capacité de mémoire qui permet à travers le clavier de mémoriser ou changer les mélodies directement sur place. L'interface pour synchronisation par radio DCF, la possibilité de dialoguer avec un ordinateur, la programmation par téléphone font de cette horloge un appareil complet et flexible.

TECHNICAL CHARACTERISTICS

- 12-24 VDC and 220 VAC independent pulses of secondary clocks with programming of the forward speed; output signals: 4 relays with 4 A (resistive load)
- Annual, periodical, weekly, cyclical and exceptional programming
- User interface with clear reading on LCD display
- Easy programming via self-guided menu
- Direct storage of any kind of festive or funeral ringing, according to the needs of the parish
- Any kind of hour striking
- Perpetual calendar for calculating leap years
- Automatic summer/winter time change
- Automatic blockage of the hammer when the bell is in motion

PUNTO4
PUN05-10-15

- RS232 connection to PC for storing and printing programs, standard output of date and time
- Electronic access code for user programming
- Safeguard for 10 years in case of power cut of all stored melodies and programs
- Battery back-up of 30 days in case of power-cut
- ON/OFF output signals on 4 relays with 4 A (resistive load)
- Timer function from 1 to 99 seconds or ON/OFF signal function for unlimited duration
- 220 VAC power supply
- Accuracy +/- 0,1 second/day at 22° C (72°F)
- Polycarbonate container with IP55 protection and transparent cover

CODE	DESCRIPTION	CONTAINER	CHANNELS	SLAVE CLOCK LINE 12/24V	TOWER CLOCK LINE 110/220 VAC	PC CONNECTION	BACKLIT DISPLAY	GPS/DCF77 MODE
PUN0504001	PUNTO4 CLOCK PLASTIC CASE	PLASTIC	4	•	•	•		•
PUN0504002	PUNTO4 CLOCK BACK LIGHTED PLASTIC CASE	PLASTIC	4	•	•	•	•	•
PUN0504003	PUNTO4 CLOCK METAL CASE	METAL	4	•	•	•		•
PUN0504004	PUNTO4 CLOCK BACK LIGHTED METAL CASE	METAL	4	•	•	•	•	•
PUN0504005	PUNTO4 CLOCK 4 CHANNELS PLASTIC CASE	PLASTIC	4			•		•
PUN0504006	PUNTO4 CLOCK 4 CHANNELS METAL CASE	METAL	4			•		•
PUN0504007	PUNTO4 CLOCK 2 CHANNELS PLASTIC CASE	PLASTIC	2		•	•		•
PUN0504008	PUNTO4 CLOCK 2 CHANNELS METAL CASE	METAL	2		•	•		•
PUN0504009	PUNTO4 CLOCK RACK VERSION	RACK	4	•	•	•		•

PUNTO4
PUN05-10-15

PUNTO4

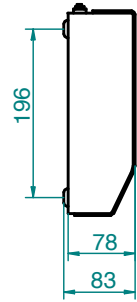
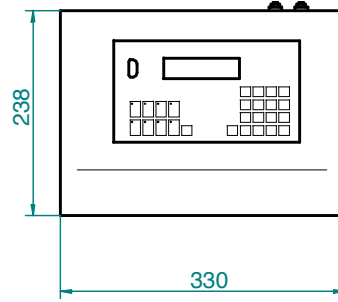

MASTER CLOCKS / HORLOGES MÈRE

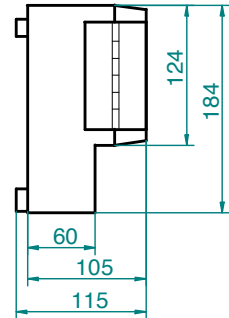
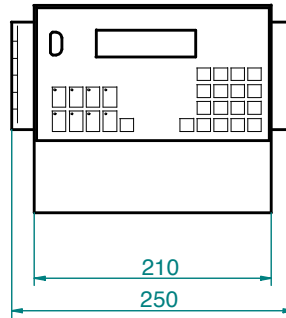

Receiver and transmitter master clock with annual programming on 4 channels and 2 independent commands for secondary clocks 12-24 VDC and 220 VAC. Particularly well suited for use in schools, hospitals, railway stations, airports, industrial plants, public buildings, department stores etc. where it is necessary to have the efficient functioning of everything at an established time.

Lighting, heating, switching on of machinery, sounding of sirens, school bells, sports hall lighting, opening of shutters, opening and closing of doors, action of escalator, garden irrigation etc., everything can be actioned at an exact and regulated time under the constant control of Punto4i.

Every problem of time switch is resolved with the various programs available: annual, periodic, cyclical, weekly, exceptional etc. Also the DCF synchronization makes it absolutely accurate.

The RS232 interface allows the synchronization of time and date of the computer to which it is connected. It is also possible, with the use of software, to program, store data, to modify and print at any time the introduced programs.

The EEPROM memory guarantees the total safeguard of data.

Horloge mère émetteur et récepteur à programmation annuelle à 4 circuits et double commande indépendante d'horloges secondaires 12-24 VDC et 220 VAC. PUNTO4i est particulièrement indiquée pour la commande de distributions horaires et d'automatismes dans les écoles, hôpitaux, gares, aéroports, bâtiments industriels, bâtiments publics, grands magasins etc.

L'horloge compte plusieurs programmes – hebdomadaires, cycliques, annuelles ou exceptionnelles – spécialement conçus pour: sonneries d'écoles, éclairage, commande de chauffage, mise en marche de machines, ouverture/fermeture de portes, mise en marche d'escaliers roulants, arrosage, essais de sirène.

La synchronisation par radio DCF en font une horloge de précision absolue qui répond à toutes vos exigences.

L'interface RS232 permet la synchronisation de l'heure et la date de vos ordinateurs.

Possibilité de programmer, changer ou imprimer à tout moment les données introduites.

La mémoire EEPROM sauvegarde la totalité des programmations.

TECHNICAL CHARACTERISTICS

- 12-24 VDC pulses of secondary clocks with programming of the forward speed; output signals: 10 W relay, with the possibility to master 30 secondaries of a standard power
- 220 VAC pulses with programming of the forward speed on 4 A relay (resistive load)
- Punto4i receiver model: it accepts 1 minute or 1/2 minute signals between 6 and 36 VDC
- Perpetual calendar for calculating leap years
- Annual, periodical, weekly, cyclical and exceptional programming
- Automatic summer/winter time change
- Electronic access code for user programming
- Easy programming via self-guided menu
- User interface with clear reading on LCD display
- RS232 connection to PC for storing and printing programs, standard output of date and time
- Connection to a computer to programme, store and print programs
- Safeguard for 10 years in case of power cut of all stored programs
- 220 VAC power supply
- Battery back-up of 30 days in case of power cut
- Accuracy +/- 0,1 second/day at 22° C (72° F)
- Polycarbonate container with IP55 protection and transparent cover

CODE	DESCRIPTION	CONTAINER	CHANNELS	SLAVE CLOCK LINE 12/24V	TOWER CLOCK LINE 110/220 VAC	PC CONNECTION	BACKLIT DISPLAY	PRED. DCF77
PUN1004001	PUNTO4 CLOCK IND. PLASTIC CASE	PLASTIC	4	•	•	•		•
PUN1004002	PUNTO4 CLOCK IND. BACK LIGHTED PLASTIC CASE	PLASTIC	4	•	•	•	•	•
PUN1004003	PUNTO4 IND. METAL CASE	METAL	4	•	•	•		•
PUN1004004	PUNTO4 CLOCK IND. BACK LIGHTED METAL CASE	METAL	4	•	•	•	•	•
PUN1004005	PUNTO4 CLOCK IND. 12/24 V 2 CHANNELS PLASTIC CASE	PLASTIC	2	•		•		•
PUN1004006	PUNTO4 CLOCK IND. 12/24 V 2 CHANNELS METAL CASE	METAL	2	•		•		•

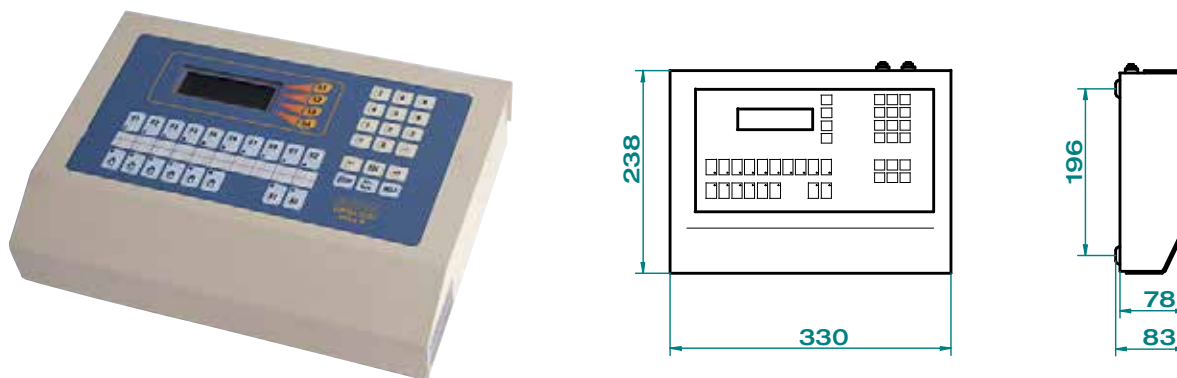
BETA8
BET05

BETA8 is a transmitter master clock that is particularly indicated for the management of automatic bells, control and illumination of clock dials, and hour striking. It is equipped with a simple control panel, by which it is possible to execute either manual sounds or automatic programs. It is possible to realise all type of sounds: bell peals, funeral toll, celebratory peal, hour strike etc. Thanks to a large capacity of memory, BETA8 is also capable of storing and executing each of the above sounds. With BETA8, it is also possible to control central heating, illumination, alarms, opening/closing doors, irrigation, sprinklers etc.

BETA8 est une horloge mère, modèle indépendant ou récepteur. Particulièrement indiquée pour la commande de cadrans d'édifices, les sonneries horaires, les programmations d'automatismes respectant les traditions locales. La programmation très simple permet d'enregistrer différents types de mélodies: carillons, sonneries en volée, tintement, glas etc. Dotée d'une grande capacité de mémoire, elle peut mémoriser un million de données, ce qui lui permet de gérer sans difficulté les programmes les plus complexes. BETA8 contrôle également les services: chauffage, éclairage, antivol, ouverture/fermeture des portes etc.

TECHNICAL CHARACTERISTICS

- Programming keyboard protected by electronic key to prevent access to unauthorized persons
- 8 function keys for manual commands and for the immediate ringing of prerecorded sounds
- 6 keys for manual ringing of bells, either in motion or strikes
- 6 service keys for suspension of sounds, hour striking, Angelus, funeral
- Simple and dynamic programming with self-guided menus in native language
- Annual, periodical, weekly, cyclical and exceptional programming
- Programming is compatible with Microsoft Windows ®
- Programming menu can be simplified and personalised according to the user requirements
- User interface with clear reading on LCD display
- Storage via keyboard of festive ringing or funerals, depending on the parishes requirements
- Strike of the hour with the possibility of excluding the ringing during the night
- 220 VAC pulses for the command of the motor for the advancement of the clock hands on the clock tower
- Perpetual liturgical calendar for the automatic programming of religious festivals: Easter, Ascension, All Saints, Christmas etc.
- Automatic change of summer/winter time
- Automatic blockage of the hammer when the bell is in motion
- RS232 connection to PC for storing and printing programs, standard output of date and time
- Manual command panel
- Back up of 30 days in case of power cut
- Safeguard of 10 years of the melodies and stored programs, in case of power cut
- Power supply 220 VAC
- Accuracy +/- 0,1 second/day at 22° C (72° F)
- ON/OFF output signal on 6 relays with 4 A, 220 V (resistive load) for the command of bells, hammers, central heating etc.

CODE	DESCRIPTION	CONTAINER	CHANNELS	SLAVE CLOCK LINE 12/24V	TOWER CLOCK LINE 110/220 VAC	PC CONNECTION	BACKLIT DISPLAY	GPS/ DCF MODE
BET0504001	BETA8 CLOCK METAL CASE	METAL	6		•	•	•	•
BET0504002	BETA8 CLOCK LARGE CASE	METAL	6		•	•	•	•
BET0504003	BETA8 CLOCK FOR RACK MODULE	RACK	6		•	•	•	•
BET0504004	BETA8 CLOCK PLASTIC CASE	PLASTIC	6		•	•	•	•

SIRIO12 SIR05

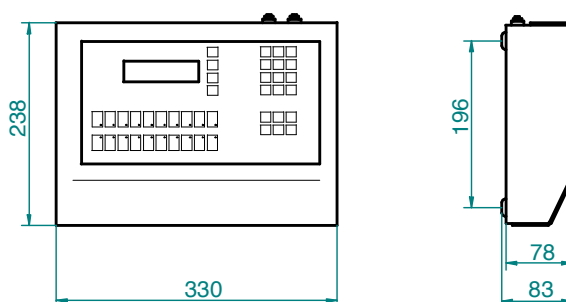

SIRIO12 is a transmitter master clock that is particularly indicated for the management of automatic bells, control and illumination of clock dials, and hour striking. It is equipped with a simple control panel, by which it is possible to execute either manual sounds or automatic programs. Faithfully respecting local traditions, it is possible to realise all type of sounds: bell peals, funeral toll, celebratory peal, hour strike etc. Thanks to a large capacity of memory, SIRIO12 is also capable of storing and executing each of the above sounds. With SIRIO12, it is also possible to control central heating, illumination, alarms, opening/closing doors, irrigation etc.

SIRIO12 est une horloge mère, modèle indépendant ou récepteur. Particulièrement indiquée pour la commande de cadrans d'édifices, les sonneries horaires, les programmations d'automatismes respectant les traditions locales. La programmation très simple permet d'enregistrer différents types de mélodies: carillons, sonneries en volée, tintement, glas etc. Dotée d'une grande capacité de mémoire, SIRIO12 peut mémoriser un million de données, ce qui lui permet de gérer sans difficulté les programmes les plus complexes. SIRIO12 contrôle également les services: chauffage, éclairage, antivol, ouverture/fermeture des portes etc.

TECHNICAL CHARACTERISTICS

- Programming keyboard protected by electronic key to prevent access to unauthorized persons
- 8 function keys for manual commands and for the immediate ringing of prerecorded sounds
- 8 keys for manual ringing of bells, either in motion or strikes
- 4 service keys for suspension of sounds, hour striking, Angelus, funeral
- 12-24 VDC and 220 VAC independent pulses with programming of the speed, output signals on 4 relays with 4 A (resistive load)
- Annual, periodical, weekly, cyclical and exceptional programming
- The programme menu can be simplified and personalized according to the user requirements
- User interface with clear reading on LCD display
- Dynamic guided menu for programming
- Storage via keyboard of any type of festive or funeral ringing, depending on the needs of the parish
- Any type of strike of the hour with the possibility of excluding the ringing during the night
- Perpetual liturgical calendar for the automatic programming of the religious festivals: Easter, Ascension Day etc.
- Automatic summer/winter time change and automatic blockage of the hammer when the bell is in motion
- RS232 connection to PC for storing and printing programs, standard output of date and time
- Programming keyboard protected by electronic key to prevent access to unauthorized persons
- Safeguard for 10 years of the stored melodies and programs, in case of power cut
- Battery back-up for 30 days in case of power cut
- ON/OFF output signals on 8 relays 5 A (resistive load) for control of the bells, central heating, illumination etc.
- Power supply 220 VAC
- Accuracy +/- 0,1 second/day at 22° C (72° F)

CODE	DESCRIPTION	CONTAINER	CHANNELS	SLAVE CLOCK LINE 12/24V	TOWER CLOCK LINE 110/220 VAC	PC CONNECTION	BACKLIT DISPLAY	GPS/ DCF MODE
SIR0504001	SIRIO12 CLOCK METAL CASE	METAL	8	•	•	•	•	•
SIR0504002	SIRIO 12 CLOCK PLASTIC CASE	PLASTIC	8	•	•	•	•	•
SIR0504003	SIRIO 12 CLOCK LARGE CASE	METAL	8	•	•	•	•	•
SIR0504004	SIRIO12 CLOCK FOR RACK MODULE	RACK	8	•	•	•	•	•

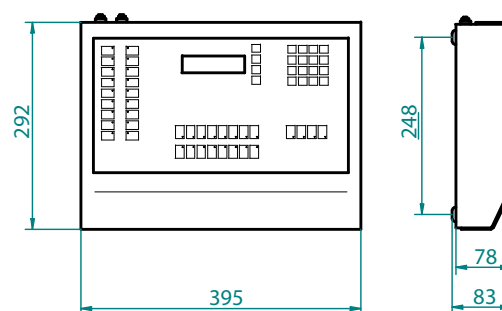
CRONOS20
CRO05

CRONOS20 is a transmitter master clock that is particularly indicated for the management of automatic bells, control and illumination of clock dials, and hour striking. It is equipped with a simple control panel, by which it is possible to execute either manual sounds or automatic programs. It is possible to realise all type of sounds: bell peals, funeral toll, celebratory peal, hour strike etc. Thanks to a large capacity of memory, CRONOS20 is also capable of storing and executing each of the above sounds. With CRONOS20, it is also possible to control central heating, illumination, alarms, opening/closing doors, irrigation, sprinklers etc.

CRONOS20 est une horloge mère, modèle indépendant ou récepteur. Particulièrement indiquée pour la commande de cadrans d'édifices, les sonneries horaires, les programmations d'automatismes respectant les traditions locales. La programmation très simple permet d'enregistrer différents types de mélodies: carillons, sonneries en volée, tintement, glas etc. Dotée d'une grande capacité de mémoire, elle peut mémoriser un million de données, ce qui lui permet de gérer sans difficulté les programmes les plus complexes. CRONOS20 contrôle également les services : chauffage, éclairage, antivol, ouverture/fermeture des portes etc.

TECHNICAL CHARACTERISTICS

- Programming keyboard protected by electronic key to prevent access to unauthorized persons
- 16 function keys for manual and immediate commands of prerecorded melodies
- 16 keys for the manual ringing of the bells, either in motion or just strikes
- 4 keys for services such as suspension of sounds, hour striking, Angelus, funeral
- Simple and dynamic programming with self-guided menus in native language
- Annual, periodical, weekly, cyclical and exceptional programming
- Programming is compatible with Microsoft Windows ®
- Programming menu can be simplified and personalised according to the user requirements
- User interface with clear reading on LCD display
- Storage via keyboard of any type of festive or funeral ringing, depending on the requirements of the user
- Any type of hour striking with the possibility of excluding the ringing during the night
- Independent recovery – 220 VAC – for the command of any type of servo-motor for the advancement of the clock hands on the bell tower
- Programmable recovery – 12-24 VDC – for secondary clocks
- Perpetual liturgical calendar for the automatic programming of religious festivals: Easter, Ascension, All Saints, Christmas etc.
- Automatic summer/winter time change
- Automatic blockage of the hammer when the bell is in motion
- RS232 connection to PC for storing and printing programs, standard output of date and time
- Control panel for manual use
- Battery back-up for 30 days in case of power cut
- Safeguard for 10 years of the memorized melodies and programs, in case of power cut
- Power supply 220 VAC
- Accuracy +/- 0,1 second/day, 22° C (72° F)
- ON/OFF output signals on 16 relays with 4 A 220 V (resistive load) for the command of bells, hammers, central heating etc.

CODE	DESCRIPTION	CONTAINER	CHANNELS	SLAVE CLOCK LINE 12/24V	TOWER CLOCK LINE 110/220 VAC	PC CONNECTION	BACKLIT DISPLAY	GPS/DCF MODE
CR00504001	CRONOS20 CLOCK METAL CASE	METAL	16	•	•	•	•	•
CR00504002	CRONOS20 CLOCK LARGE CASE	LARGE CASE	16	•	•	•	•	•
CR00504003	CRONOS20 CLOCK FOR RACK MODULE	RACK	16	•	•	•	•	•

TIDECLOCK CLK30

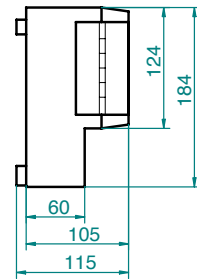
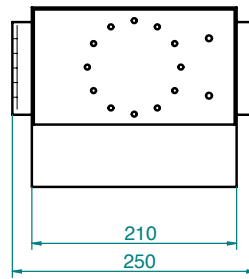

Master clock specifically designed to show the high and low tide. It can be used by non-expert users, supplied with a particularly simple and strong interface. Supplied in a polycarbonate container with IP55 protection, the unit is able to withstand the particularly difficult climate conditions found close to the sea.

Can be used paired with a double sided clock for outdoor use, mounted or not on a pole (see TAM05-10, p.23) or as a master clock for large-size facade clocks (see RIC05-10-15-20-25-30, p. 72).

It can be used paired with one or more clock dials following the graphic scheme as illustrated in the example.

Horloge mère étudiée pour indiquer la haute ou la basse marée. Cette horloge a été prévue pour être utilisée par de personnes qui ne sont pas des experts et a une interface très simple et robuste. C'est douée d'une boîte en polycarbonate avec degré de protection IP55 et peut bien résister aux conditions très sévères des milieux de mer.

Peut être également utilisée en accouplement à une horloge double face pour extérieur, assemblé ou pas sur colonne (v. TAM05-10, p.23) ou comme horloge mère pour un grand cadran installé sur la façade d'un bâtiment ou d'une tour (v. RIC05-10-15-20-25-30, p. 72).

Tidelock doit être utilisé en accouplement avec un ou plus cadrans réalisés selon le schéma graphique indiqué dans la figure.

TECHNICAL CHARACTERISTICS

- Power supply: 220 VAC-115 VAC
- Robust and high contrast LED/SWITCH analog interface
- Control of the clock dials via 2 channels with phase inversion
- Back up of 25 days in case of power cuts
- Nickel metal hydride rechargeable battery for the back up
- Accuracy to +/- 0,1 seconds/day at 22°C (72° F)
- Body in polycarbonate with IP55 protection and transparent cover
- Time base: moon cycle

CODE	DESCRIPTION
CLK3004001	TIDECLOCK
CLK3004002	TIDECLOCK 110V

DCF RADIO SYNCHRONISED CITYCLOCK / CITYCLOCK RADIO SYNCHRONISÉE DCF

CIT05-09

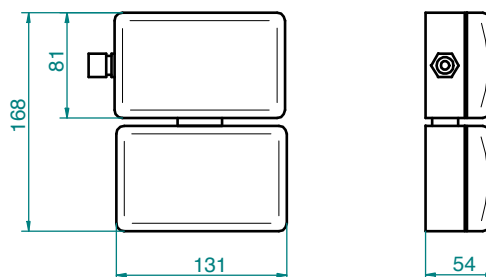

This master clock controls city and advertising clocks with two/three/four clock faces.
It runs on lithium batteries that guarantee up to 9 years' operation.
Total precision and no maintenance.
It has a quartz timebase with DCF77 reception and synchronisation

Horloge électronique de contrôle adaptée pour le contrôle des horloges de ville et publicitaires à deux-quatre faces.
Alimentation avec piles au Lithium qui garantissent jusqu'à 9 ans de fonctionnement.
Précision absolue et absence d'entretien.
Elle est dotée d'une base temps au quartz avec dispositif de réception et de synchronisation via radio DCF77.

TECHNICAL CHARACTERISTICS

- Autonomous functioning: 8 years for two clock dials diameter 80 cm (31,5 in)
- Absolute accuracy of the time
- Adjustable aerial to maximise the signal reception
- Maintenance free
- Self-setting of the secondary clocks
- Excellent value for money – Made in Italy
- Short circuit protection: entry current 50 mA, insertion time 1ms
- Duration of the programmable impulse: 0,25 s, 0,5 s
- Power supply of secondary clocks: max 35 VDC
- Impulses are memorized in case of battery being disconnected or insufficient voltage
- Reset of correct time upon replacement of flat battery of the secondary clocks
- Change of summer/winter time programmable from a table or via RADIO signal
- Choice of change between LAST SUNDAY OF SEPTEMBER, LAST SUNDAY OF OCTOBER, FORTH SUNDAY OF OCTOBER
- Box in ABS, IP55 protection
- Led to check the quality of the radio signal
- Absolute precision (1 thousandth of a second/year) with DCF signal
- Weight: 600 g (21,16 oz)

CODE	DESCRIPTION
CIT0504002	CITYCLOCK WITH BATTERY 10.8 VDC DCF RADIOSYNCHRONIZED
CIT0904002	CITYCLOCK WITH 220VAC POWER DCF RADIOSYNCHRONIZED

GPS SYNCHRONISED CITYCLOCK / CITYCLOCK SYNCHRONISÉE GPS

CLK35

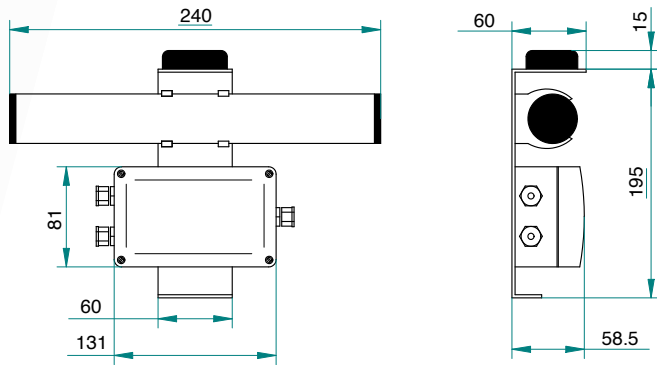

The innovative GPS-CITYCLOCK project stems from the experience of ECAT engineers and their desire to develop a precise, inexpensive and maintenance-free clock. Now GPS-CITYCLOCK makes this a reality. The result is a clock with an automatic hand-positioning and GPS synchronisation device that is totally independent, exploiting its long battery life (up to 9 years).

In the event of synchronisation-signal black-out, the clock continues to work with its internal quartz, self-synchronising when signal reception returns. Automatic daylight saving time changes.

Le projet innovant CITYCLOCK-GPS est le fruit de l'expérience des ingénieurs ECAT et de leur ambition à créer une horloge précise, économique et en même temps sans entretien. Aujourd'hui CITYCLOCK-GPS transforme cette ambition en réalité: le résultat c'est une horloge dotée d'un système de réglage automatique de la position des aiguilles et de synchronisation GPS, un dispositif en mesure de se gérer en indépendance totale en bénéficiant de sa grande autonomie de fonctionnement à piles (jusqu'à 9 ans).

En cas de black-out du signal de synchronisation l'horloge continue à fonctionner avec le quartz interne, en s'auto synchronisant à la reprise de la réception du signal. Changement automatique de l'heure légale/solaire.

TECHNICAL CHARACTERISTICS

- Autonomous functioning: 9 years for two clock dials diameter MAX 90 cm
- Absolute precision (1 thousandth of a second/year) with GPS signal
- System for self-correction of hands position of hands (see SEC10, p. 83)
- Maintenance free
- Adjustable/removable aerial to maximise the signal reception
- LED to check the quality of the radio signal
- Self-setting of the secondary clocks
- Impulses are memorized in case of battery being disconnected or insufficient voltage
- Impulse of secondary clocks. Programmable impulse: 0.25 s, 0.5 s
- Protection for secondary clocks. Short circuit protection: entry current 50 mA, insertion time 1ms
- MASTER signal output: to synchronize multiple CITYCLOCK
- Programmable time zone
- Automatic change summer/winter time
- Case in break resistant ABS, protection IP55
- Weight: 950 g

CODE	DESCRIPTION
CLK3504001	CITYCLOCK WITH BATTERY 10.8 VDC GPS SYNCHRONIZED
CLK3504002	CITYCLOCK WITH BATTERY 220VAC GPS SYNCHRONIZED

ACCESSORIES

CODE	DESCRIPTION
CLK0504001	PUNTO SP1 CLOCK FULL VERSION
CLK0504002	PUNTO SP1 CLOCK FULL VERSION 110V
CLK0504020	PUNTO SP1 CLOCK STANDARD VERSION
CLK0504021	PUNTO SP1 CLOCK STANDARD VERSION 110V
CLK0504022	PUNTO SP1 CLOCK BASIC VERSION
CLK0504023	PUNTO SP1 CLOCK BASIC VERSION 110V
CLK0504040	PUNTO SP1.DODICI CLOCK 110/220V
CLK0504050	PUNTO SP1.VENTI CLOCK 110/220V
CLK0504060	PUNTO SP1 RACK CLOCK 110/220V
CLK0504070	PUNTO SP1 CLOCK "LARGE CASE" 110/220V
PUN0504001	PUNTO4 CLOCK PLASTIC CASE
PUN0504002	PUNTO4 CLOCK BACK LIGHTED PLASTIC CASE
PUN0504003	PUNTO4 CLOCK METAL CASE
PUN0504004	PUNTO4 CLOCK BACK LIGHTED METAL CASE
PUN0504005	PUNTO4 CLOCK 4 CHANNELS PLASTIC CASE
PUN0504006	PUNTO4 CLOCK 4 CHANNELS METAL CASE
PUN0504007	PUNTO4 CLOCK 2 CHANNELS PLASTIC CASE
PUN0504008	PUNTO4 CLOCK 2 CHANNELS METAL CASE
PUN0504009	PUNTO4 CLOCK RACK VERSION
PUN1004001	PUNTO4 CLOCK IND. PLASTIC CASE
PUN1004002	PUNTO4 CLOCK IND. BACK LIGHTED PLASTIC CASE
PUN1004003	PUNTO4 CLOCK IND. METAL CASE
PUN1004004	PUNTO4 CLOCK IND. BACK LIGHTED METAL CASE
PUN1004005	PUNTO4 CLOCK IND. 12:24V 2 CHANNEL PLASTIC CASE
PUN1004006	PUNTO4 CLOCK IND. 12:24V 2 CHANNEL METAL CASE
BET0504001	BETA8 CLOCK METAL CASE
BET0504002	BETA8 CLOCK LARGE CASE
BET0504003	BETA8 CLOCK FOR RACK MODULE
BET0504004	BETA8 CLOCK PLASTIC CASE
CRO0504001	CRONOS20 CLOCK METAL CASE
CRO0504002	CRONOS20 CLOCK LARGE CASE
CRO0504003	CRONOS20 CLOCK FOR RACK MODULE
SIR0504001	SIRIO12 CLOCK METAL CASE
SIR0504002	SIRIO12 CLOCK PLASTIC CASE
SIR0504003	SIRIO12 CLOCK LARGE CASE
SIR0504004	SIRIO12 CLOCK FOR RACK MODULE
CLK3004001	TIDECLOCK 220V
CLK3004002	TIDECLOCK 110V
CIT0504002	CITYCLOCK WITH BATTERY 10.8 VDC DCF RADIOSYNCHRONIZED
CIT0904002	CITYCLOCK WITH 220VAC POWER DCF RADIOSYNCHRONIZED
CLK3504001	CITYCLOCK WITH BATTERY 10.8 VDC GPS SYNCHRONIZED
CLK3504002	CITYCLOCK WITH BATTERY 220VAC GPS SYNCHRONIZED
CAS1001008	PROTECTION FOR PUNTO4 BASIC VERSION
CAV-KIT-GPS-6P6C	LINE CORD CABLE 6P6C FOR CLK35
CAV-KIT-TAM	WIRING KIT FOR CIT05-09
CAV09/RS232	RS232 CONNECTION CABLE CLOCK - PC
CLK9004001	FIRMWARE PROGRAMMING TERMINAL USB PUNTO SP1 CLOCK
CLK9004002	PIANO KEYBOARD 2 OCTAVES
CLK9004010	SCHEDA INTERFACCIA INGRESSI ESTERNI SP1
CLK9004015	SCHEDA INTERFACCIA TASTIERA MUSICALE MIDI SP1
CSM-S20	S20 INTERFACE CARD FOR SLAVE MOVEMENT SEC05
FIL04001	ADDITIONAL FILTER 220V - 20 VA
FRT0504003	FERRITE RING FOR POWER SUPPLY PROTECTION
RCG9504001	PANEL FOR SWITCHES
RDE0504001	RADIO SYNCHRONIZER DCF ECAT FOR INDOOR INSTALLATION
RDE0504002	RADIO SYNCHRONIZER DCF ECAT FOR OUTDOOR INSTALLATION
RDE1004001	SYNCHRONIZER GPS ECAT